

Hot-spot method for alignment of forward proton detectors at the LHC

Paweł Buglewicz



Cracow University of Technology

Epiphany 7-9.01.2016

Diffractive Processes

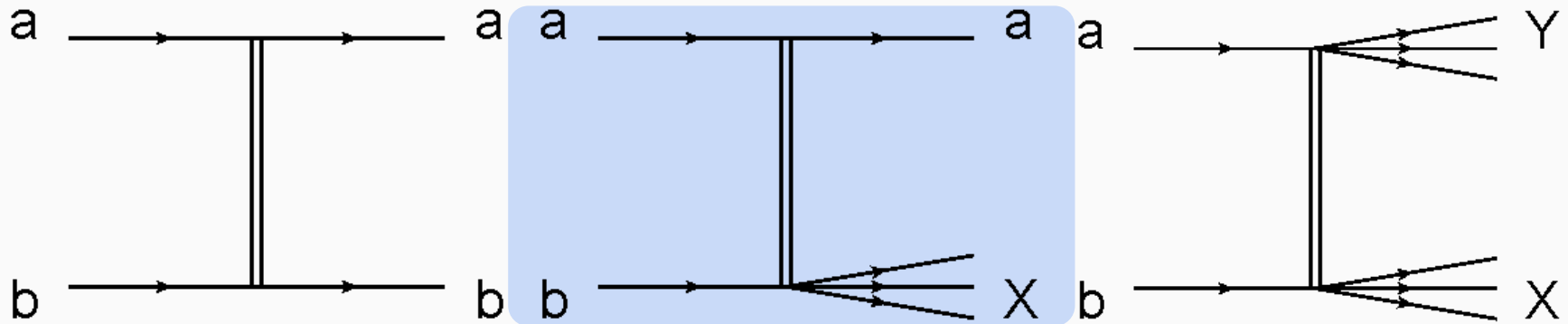

- ❑ pp interaction,
- ❑ color singlet (Pomeron) exchange,
- ❑ hard & soft diffractive processes
- ❑ diffractive signatures:
 - ❑ large rapidity gap
 - ❑ intact forward proton

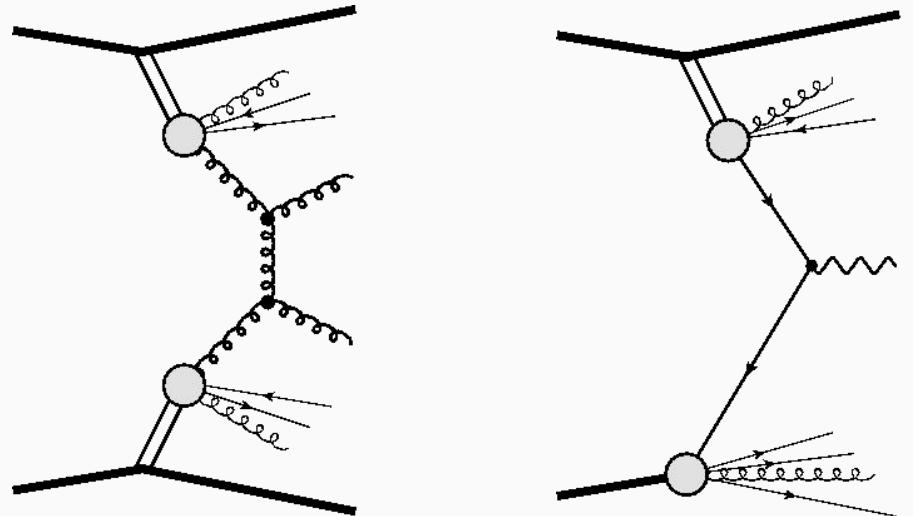

Example: ATLAS Forward Proton (AFP) detectors

Measurement of protons scattered at very small angle that escape the acceptance of central detectors:

- ❑ ~200 m from IP
- ❑ Few mm from the beam
- ❑ 4 stations: 2+2 (0+2 in first phase)
- ❑ Tracker - 4 layers of silicon pixel detector
- ❑ Tracker resolution (x,y):
 - ❑ 10 μ m x 30 μ m
- ❑ ToF detectors in outer stations

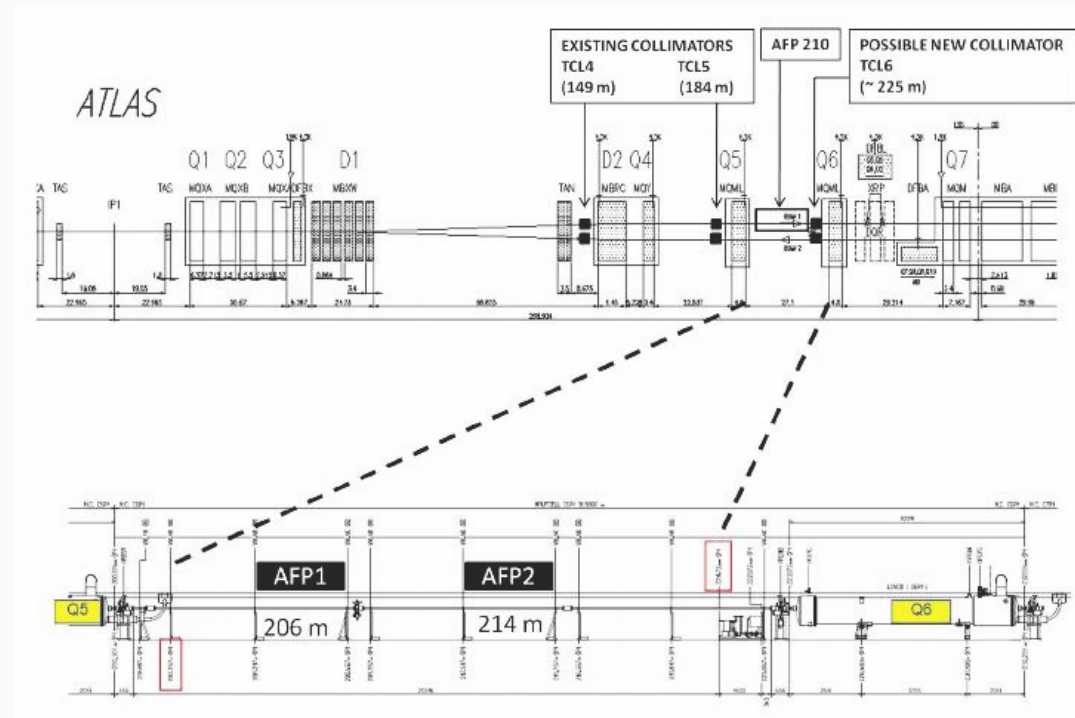

Motivation

Detectors are placed in roman pots - measurement inside the LHC beam pipe.

Moved in and out for every run → position of detectors changes very often.

Precise information about the position needed for data analysis.

A need for dedicated alignment methods.

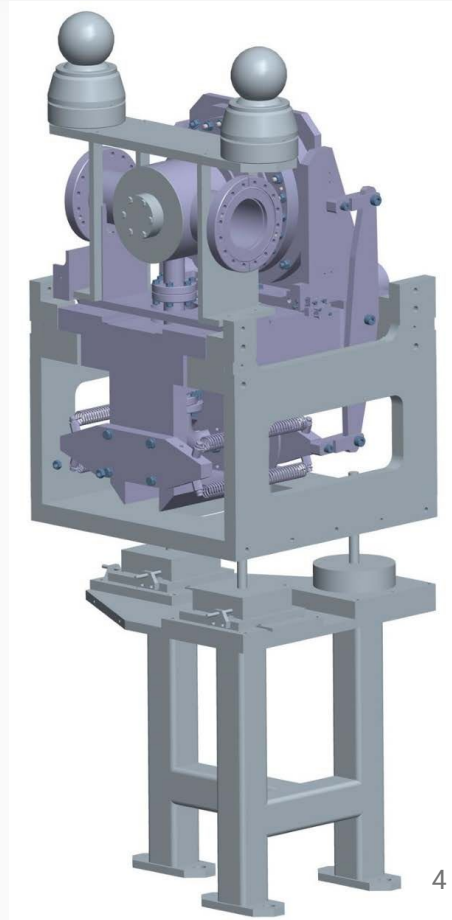

Proton transport & hit pattern

Particles are transported through LHC lattice.

Characteristic pattern due to properties of LHC optics.

Hot-spot alignment method: positioning the detector w.r.t. the narrow region.

Proton position distribution at 204m in LHC

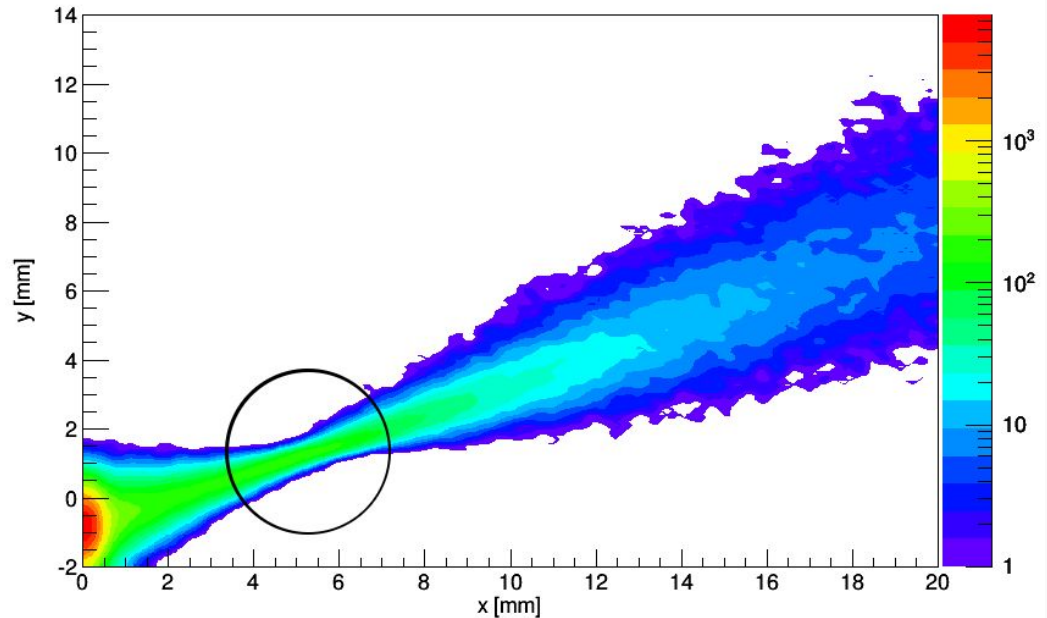

Width measurement

Proton position distribution at 204 m at LHC

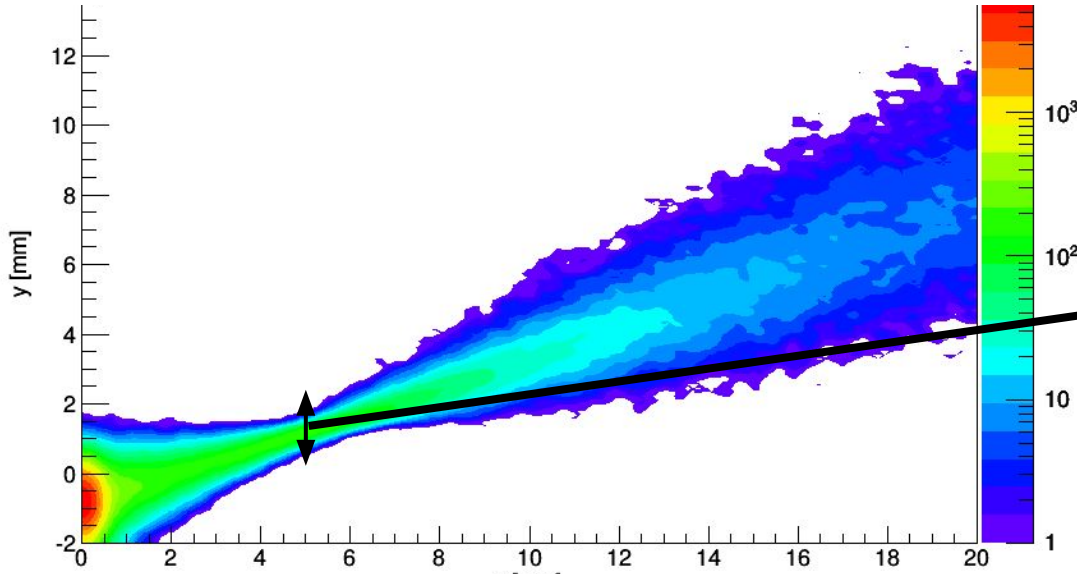

Distribution of y for x=5 mm

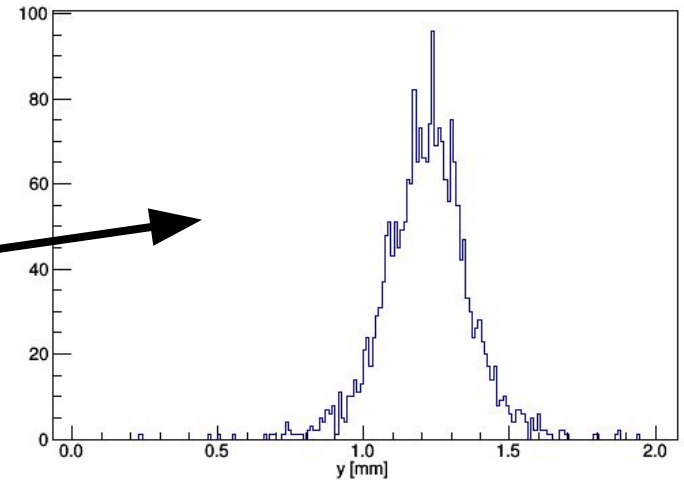

- Width in y measured in bins of x
- Methods of width measurement
 - Gaussian width
 - Standard deviation

Position of the narrow region

For each x bin a width value (w) is found.

A clear minimum is observed in $w(x)$.

A 2nd rank polynomial is fitted to $w(x)$.

Minimum of the polynomial gives the hot-spot position.

RMS as a function of distance.

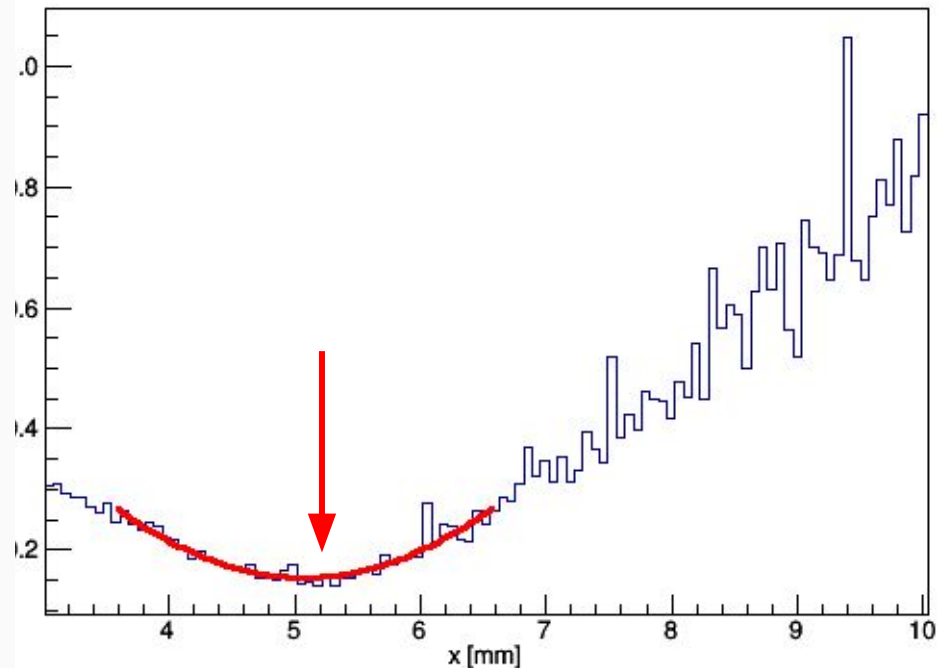

Statistical uncertainty of the method

Statistical Uncertainty:

Bootstrap is a statistic method of evaluating statistical uncertainties. From a given sample a new statistically independent sample is created.

(New histogram is filled with new values drawn from Poisson distribution with mean from the original histogram).

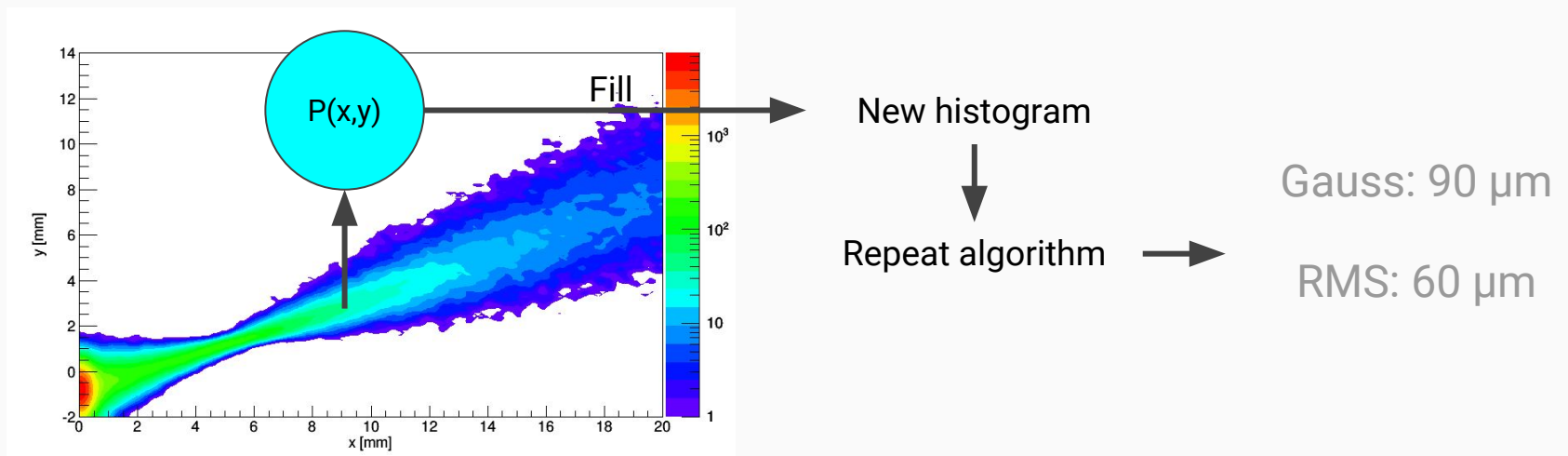

Systematic uncertainties

Systematic uncertainties:

(for 600K events registered by detectors 3 mm from the beam, which corresponds to integrated luminosity of $200 \mu\text{b}^{-1}$)

- ❑ Method for width measurement:
 - ❑ **Difference between RMS and Gaus: $240 \mu\text{m}$**
- ❑ Details of the algorithm
 - ❑ Bin size: RMS: $40 \mu\text{m}$, Gaus: $20 \mu\text{m}$:
 - ❑ Polynomial fit range: RMS $70 \mu\text{m}$, Gaus $30 \mu\text{m}$
- ❑ Physics/background
 - ❑ SD vs SD+DD: **RMS - $65 \mu\text{m}$** , Gaus: $4 \mu\text{m}$

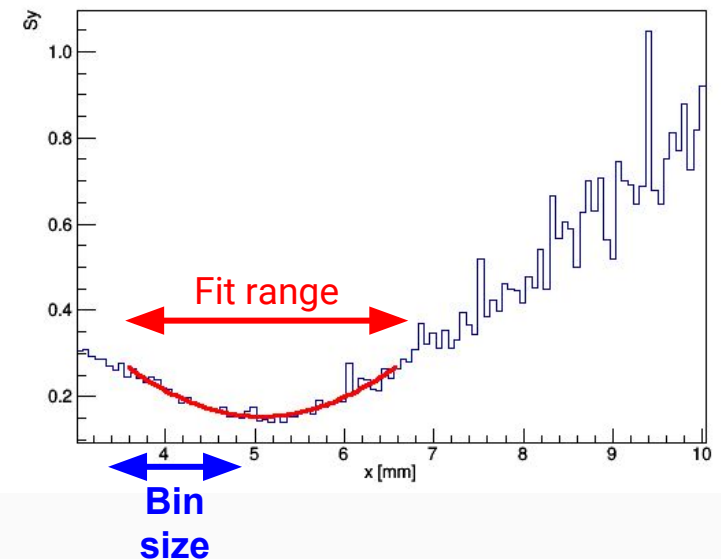

Summary

- ❑ Physics motivation - diffractive processes with intact forward protons
- ❑ Measurement with dedicated detectors, e.g. AFP
- ❑ Roman pot mechanism → detectors change position every run
- ❑ Need for dedicated alignment methods

- ❑ Hot-spot method - positioning w.r.t. narrow region in hit pattern
- ❑ Measurement of y-width in bins of x: std. dev. / Gauss
- ❑ Position of the minimum obtained from a quadratic fit
- ❑ Studies of uncertainty sources: statistical and systematic

Thank You for Your attention!